



VESTA-660/1000

Software-Optimized Advanced Vertical Machining Centers







SOFTWARE-OPTIMIZED VERTICAL MACHINING CENTER

Introducing the faster, more precise, more reliable vertical machining center for component machining.

Hwacheon's machining software monitors many environment and machining condition related variables and makes optimized adjustments for the best quality results at optimum work efficiency.

1 Engine Block / Auto mobile / Aluminum 2 Semiconductor equipment part / Semiconductor / Aluminum 3 Semiconductor equipment part / Semiconductor / Aluminum 4 Mani-Fold / Automobile / Aluminum 5 Aerospace Part / Aerospace / AL6061

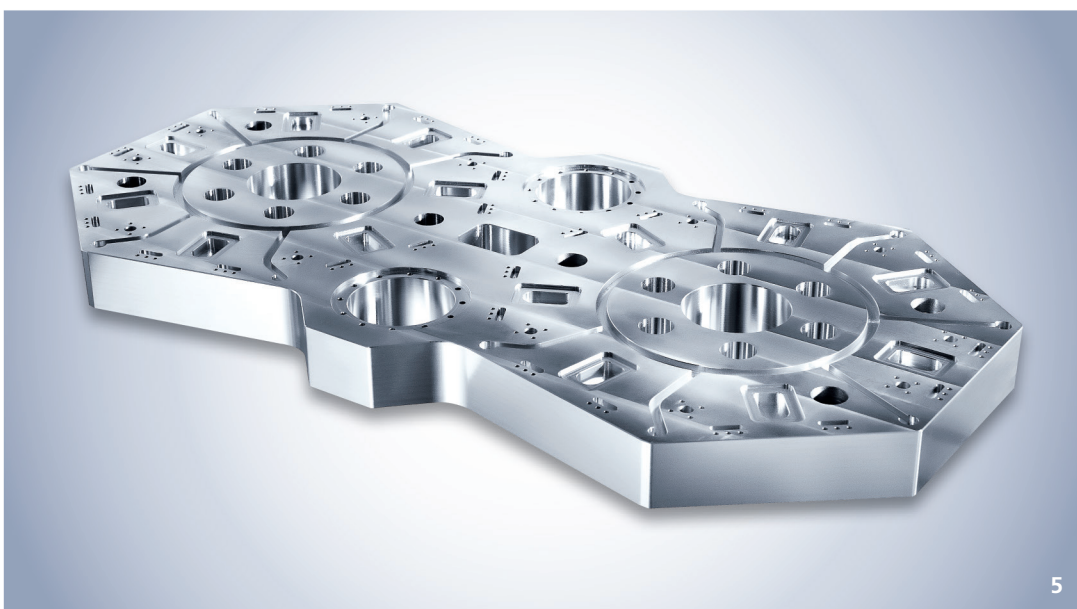
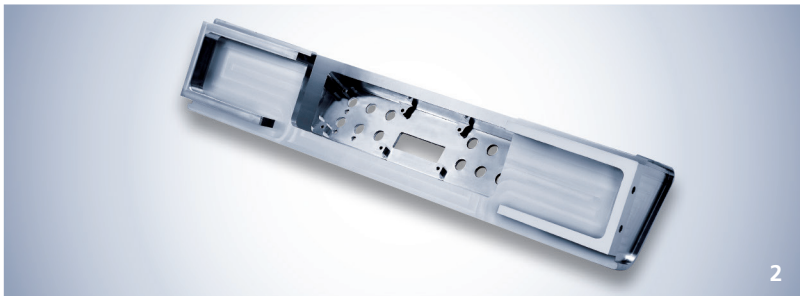



SUPER FAST ROUGHING AND ULTRA PRECISE FINISHING PERFORMANCE

The VESTA series of machining centers are the result of Hwacheon's technological innovation.

These high-performance machines are optimized for job shop machining applications, with the easy-to-use interface to maximize your productivity. HTLD increases the life of your tools; HECC provides perfect contour control for better machining efficiency; OPTIMA controls the feedrate and HTLD adjusts the temperature in real time. To minimize thermal displacement and to increase the life of the spindle assembly, the spindle unit is grease-lubricated and jacket cooled. The advanced feed drive complements the spindle for highly precise machining result every time. The super tough roller guide keeps its precision even at high speeds, and offers a variety of options for your convenience. Last but not least, VESTA's advanced chip removal and lube separation system help to save cost.



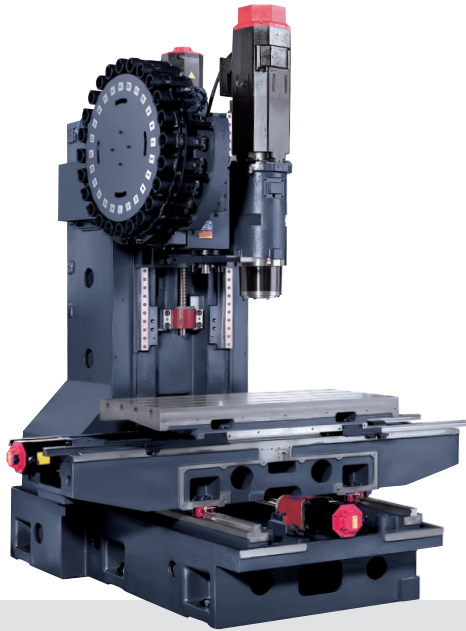

Machining example using HECC®

[Cutting time per HECC level]

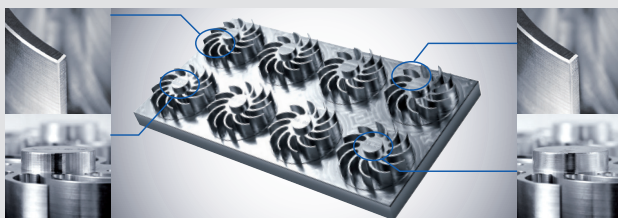
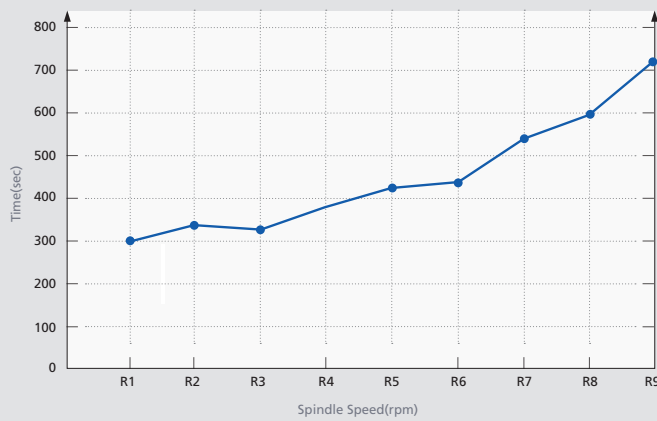

You can program the HECC system to operate in Fast Mode to prioritize speed over precision such as roughing; or have it run in Precision Mode when finish cutting. Better yet, you don't need to modify parameters every time you change your work you can easily switch from one mode to another by entering the NC data. This feature works not just for speed and precision, but also for setting the level of smoothness of the surface on a workpiece.



HTDC usage example

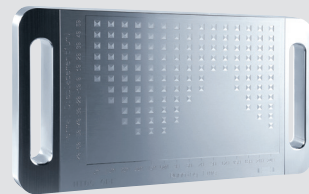

OFF

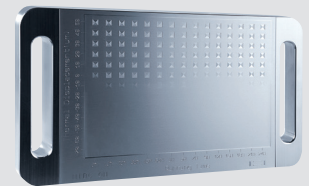

ON

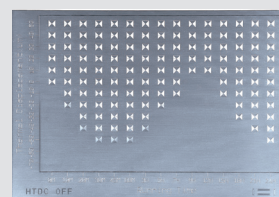

Max.60µm / 24hr

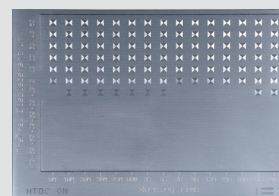

Max.10µm / 24hr

HTDC monitors the temperature of different section of the machine with the highly sensitive sensors integrated within the spindle and the frame, to maintain the level of precision over long hours of operation. The left sample demonstrates how the precision level changes when the HTDC (Hwacheon Thermal Displacement Control) is turned off and on, to show that HTDC effectively helps to produces consistent machining results after 24 hours of operation.





MACHINING SOFTWARE

The Hwacheon Machining Software Components

The Hwacheon's developed machining software monitors different variables related to the work environment and machining conditions and makes adjustments for best quality results and optimum work efficiency.

+ RELIABILITY

HTDC (HSDC + HFDC) Hwacheon Thermal Displacement Control System (HSDC + HFDC)

HTDC integrates the Hwacheon Spindle Displacement Control system and the Frame Displacement Control System.



HFDC Hwacheon Frame Displacement Control System

HFDC is equipped with highly sensitive thermal sensors in the casting region where thermal activity is suspected; monitoring and correcting displacement.



HSDC Hwacheon Spindle Displacement Control System

When the spindle rotates at high speed, the centrifugal force drives the taper to expand, causing errors in Z axis. HSDC constantly monitors the temperature at each spindle region and makes optimal prediction for thermal displacement. The system then makes necessary adjustments and effectively minimizing thermal displacement.



Static displacement compensation

The HSDC system corrects the Z-axis error occurring from the taper expansion during the spindle's high speed rotation.

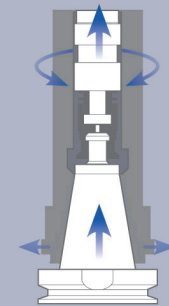



PRECISION +

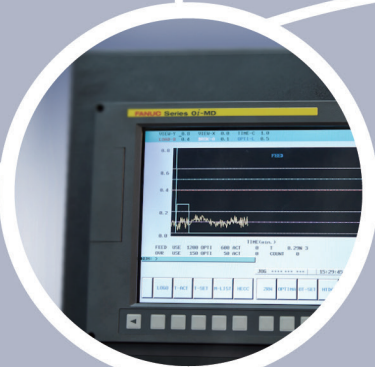

HTLD

Hwacheon Tool Load Detect System

HTLD constantly monitors the tool wear to prevent accidents, which may occur from a damaged tool and help to stop tool wear from deteriorating the workpiece.
(The load is measured every 8 msec to ensure accuracy)



HECC

Hwacheon High-Efficiency Contour Control System

HECC offers an easy-to-use programming interface for different work-pieces and different processing modes. The system provides a precise, custom contour control for the selected workpiece, while prolonging the life of the machine and decreasing process time. The customizable display provides real-time monitoring and quick access.

- Program offers different options for different cutting speed and accuracy for roughness and shapes.
- The customizable display provides real-time monitoring and quick, easy access.
- The program is executable on an existing NC DATA system and works with the G Code system.



OPTIMA

Cutting Feed Optimization System

OPTIMA utilizes an adaptive control method to regulate the feed rate in real time, to sustain the cutting load during a machining process. As a result the tools are less prone to damage and the machining time is reduced.



SPEED +



USER FRIENDLY DESIGN, A WIDE RANGE OF OPTIONAL FEATURES

The VESTA-660/1000 system offers user friendly design and a wide variety of useful options for practical applications, so you can concentrate on what you do best: creating quality products without losing your valuable time to the worries of machine failure and safety. A wide variety of performance upgrade options are available for faster, more precise machining.

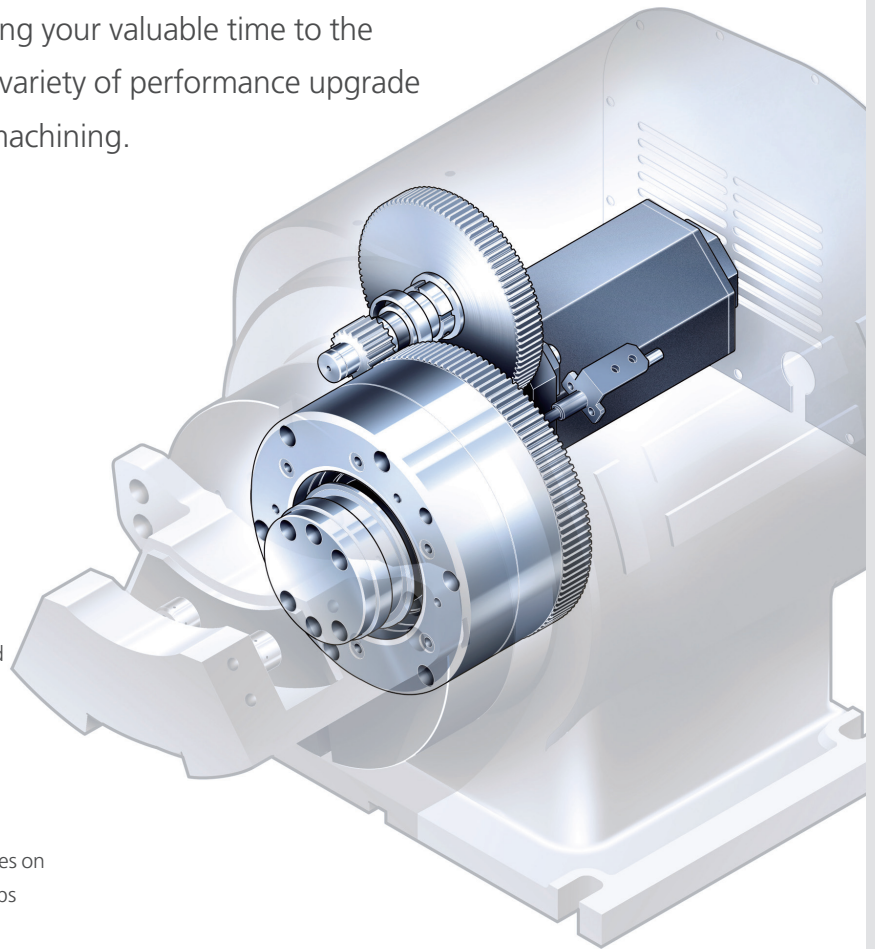

Index Table (Option)

Hwacheon's index table can be operated with ease without the need for additional 4-axis interface, and its 4.3 tons of clamping force and 5 degrees of division angle are ideal for hard turning.

Fast Chip Removal Performance

The chip removal section in VESTA series of machining centers are designed with a wide-angle sliding cover and the chip flushing nozzles on each side of the table; and the coil conveyor in front removes the chips quickly and effectively, to make your work more efficient.

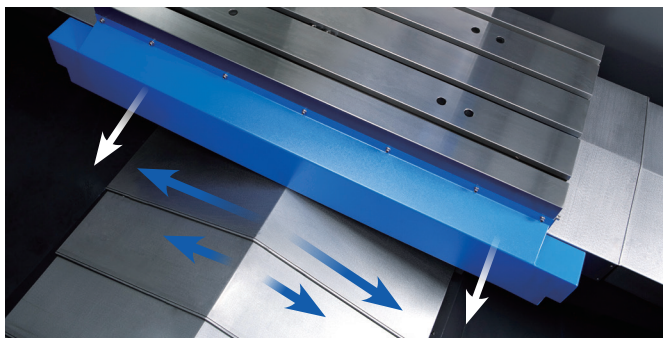

Product Data

■ VESTA-660 ■ VESTA-1000

* Unit: mm(inch)

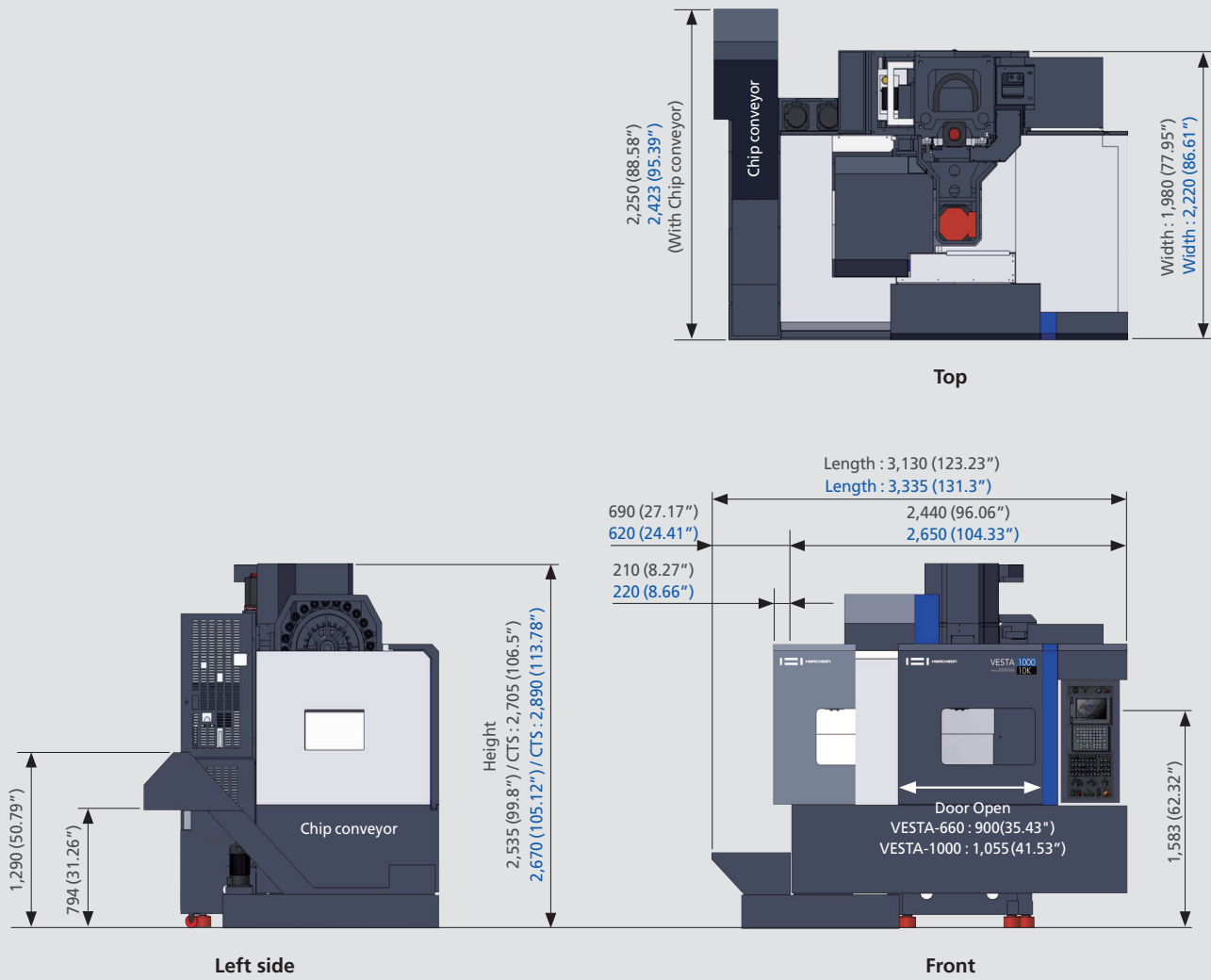

Spindle Power – Torque Diagram

VESTA-660 (STD)

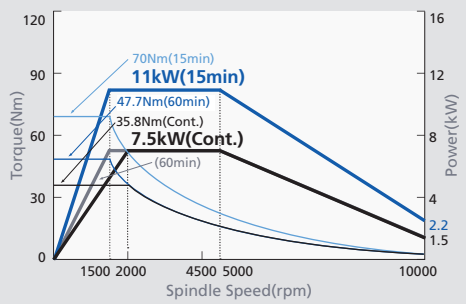

VESTA-1000 (STD)

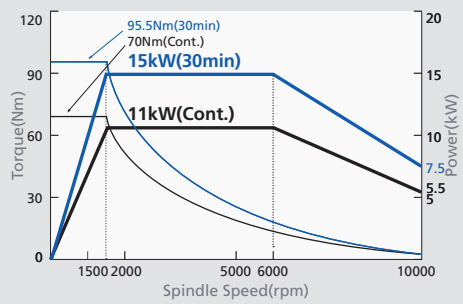

VESTA-660/1000 (Through-Spindle)

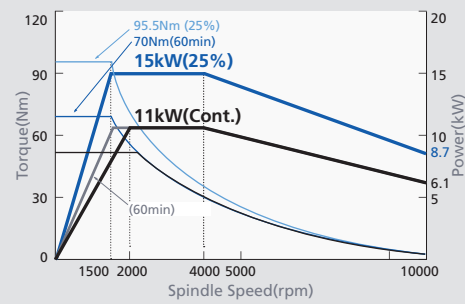

Product Configuration

Each product can be configured to fit your application.

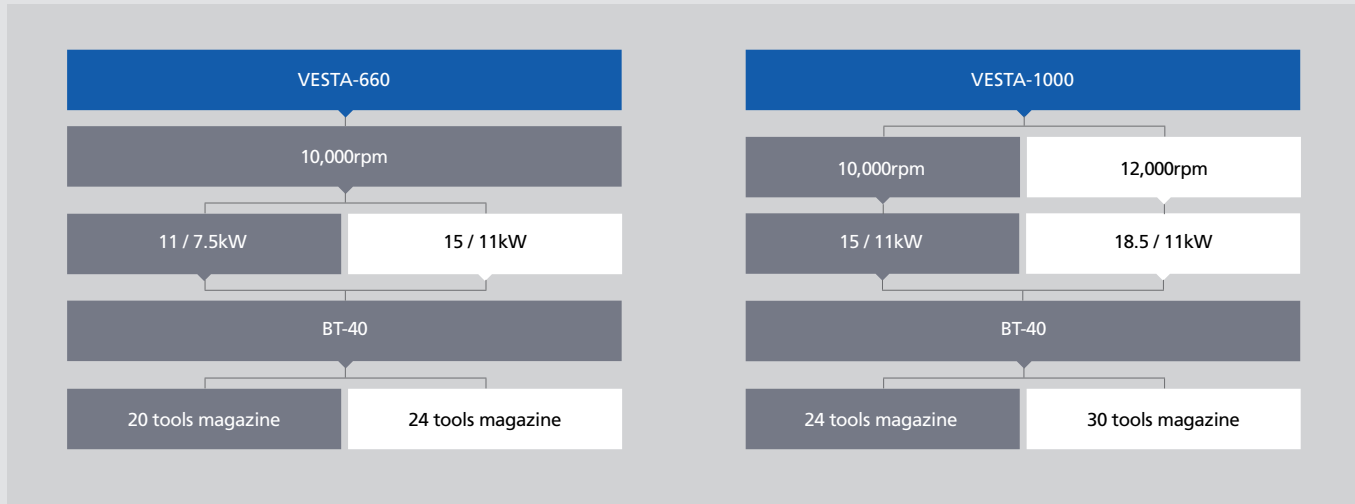

Machine Specifications

ITEM		VESTA-660		VESTA-1000	
		BT-40		BT-40	
		11 / 7.5	15 / 11	15 / 11	18.5/11
Travel					
Stroke (X / Y / Z)	mm(inch)	660 (25.98") / 430 (16.93") / 400 (15.75")		1,000 (39.37") / 550 (21.65") / 500 (19.69")	
Distance from Table Surface to Spindle Gauge Plane	mm(inch)	150 (5.91") ~ 550 (21.65")		130 (5.12") ~ 630 (24.8")	
Table					
Working Surface	mm(inch)	720 (28.35") x 400 (15.75")		1,100 (43.31") x 502 (19.76")	
Table Loading Capacity	kg _r (lb _r)	560 (1,234)		700 (1,543)	
Table Surface Configuration (T slots WxP – No. of slots)	mm(inch)	18 (0.71") x 100 (3.94") - 3ea		18 (0.71") x 80 (3.15") - 5ea	
Spindle					
Max. Spindle Speed	rpm	10,000		10,000	12,000
Spindle Motor	kW(HP)	11 / 7.5 (15 / 10)	15 / 11 (20 / 15)	15 / 11 (20 / 15)	18.5 / 11 (25 / 15)
Feedrate					
Rapid Speed (X / Y / Z)	m/min(ipm)	36 (1,417) / 36 (1,417) / 30 (1,181)			
Feedrate (X / Y / Z)	mm/min(ipm)	1 (0.04) ~ 24,000 (945)			
ATC					
Type of Tool Shank	-	MAS-403 BT-40 (Opt.: CAT-40)			
Type of Pull Stud	-	MAS P40T-1 (45°)			
Tool Storage Capacity	ea	20 (24)		24 (30)	
Max. Tool Diameter [Without Adjacent Tools]	mm(inch)	Ø80 (3.15") / Ø150 (5.91")		24Tools: Ø80 (3.15") / Ø150 (5.91") 30Tools: Ø75 (2.95") / Ø150 (5.91")	
Max. Tool Length	mm(inch)	300 (11.81")			
Max. Tool Weight	kg _r (lb _r)	8 (17.64)			
Motor					
Feed Motor (X / Y / Z)	kW(HP)	1.8 (2.4) / 1.8 (2.4) / 3.0 (4.0)		1.8 (2.4) / 1.8 (2.4) / 3.0 (4.0)	
Coolant Motor (Spindle / Chip Flushing)	kW(HP)	0.4/0.4 (0.54/0.54)			
Spindle Cooler (50 / 60Hz) – Inverter Type	kW(HP)	0.18 (0.24)		0.4 (0.54)	
Power Source					
Electric Power Supply	kVA	25	30	30	
Compressed Air Supply (Pressure X Consumption)	-	0.5 ~ 0.7MPa x 690Nl/min			
Tank Capacity					
Spindle Cooling / Lubrication	ℓ (gal)	20 (5.28) / 6 (1.59)			
Coolant	ℓ (gal)	320 (84.54)		380 (100.39)	
Machine Size					
Height	mm(inch)	2,535(99.8")		2,670(105.12")	
Floor Space (Length x Width)	mm(inch)	3,130 (123.23") x 1,980 (77.95")		3,335 (131.3") x 2,200 (86.61")	
Weight	kg _r (lb _r)	4,300 (9,479.88)		6,500 (14,330)	
NC Controller		Fanuc-0i MF			

Standard and Optional product components

Standard Accessories		Optional Accessories	
• Adjust Bolt, Block & Plate	• Tool Kit & Box	• Air Dryer	• Signal Lamp (R / G / Y, 3 Color)
• Air Blower	• Work Light	• Air Gun	• Spindle Cooler (Oil Cooler Type)
• Base Around Splash Guard	• Workpiece Coordinate System (48ea)	• Auto Door	• Tool Measuring System-Renishaw / Blum (Touch Type, Laser Type)
• Coolant System	• 10.4" Color LCD	• Coolant Gun	• Transformer
• Coil Conveyor (1ea)	• Hwacheon Artificial Intelligence Control System (HAI) 40 block	• Coolant Through Spindle (30bar, 70bar)	- VESTA-660:25kVA-11/7.5kW/30kVA-15/11kW
• Door Interlock	• Hwacheon Efficient Contour Control System (HECC)	• Data Server Interface	- VESTA-1000:30kVA
• Ethernet Interface	• Hwacheon Tool Load Detect System (HTLD)	• Data Server (256MB / 1,024MB)	• Workpiece Measuring System
• Lubrication System	• Hwacheon Thermal Displacement Control System (HTDC)	• High Pressure Coolant 6bar	- Renishaw / Blum (Touch Type)
• Lub. Oil Separation Tank	• Cutting Feed Optimization System (OPTIMA)	• Lift Up Chip Conveyor (Hinge Type, Scraper Type)	• 4-Axis Interface
• MPG Handle (1ea)	• Hwacheon Thermal Displacement Control System (HTDC)	• Linear Scale (X / Y / Z)	• 15" Color LCD (only FANUC)
• Operation Manual & Parts List	- Hwacheon Spindle Displacement Control System (HSDC) +	• NC Cooler	• Hwacheon Artificial Intelligence Control System (HAI) 200 / 400 Block
• Part Program Storage Length 1,280m (512kB)	- Hwacheon Frame Displacement Control System (HFDC)	• Manual Guide i	
• Pneumatics System		• Mist Collector	
• Rigid Tapping		• MPG Handle (3ea)	
• Signal Lamp (R / G, 2 Color)		• Oil Mist (Semi Dry Cutting System)	
• Spindle Cooler (Fan Cooler Type)		• Oil Skimmer	

NC Specifications [Fanuc Oi-MF]

※ — : Not available S : Standard O : Option

ITEM	SPECIFICATION	ITEM	SPECIFICATION
Controlled axis		Rigid tapping	S
Controlled axis	3 - Axes	Tool function / compensation	
Controlled axis	5 - Axes (Max.)	Tool function	T4 - digits S
Simultaneously controlled axes	3 - Axes	Tool offset pairs	±6 - digits 400ea S
Simultaneously controlled axes	4 - Axes (Max.)	Tool offset memory C	S
Least input increment	0.001mm, 0.001deg, 0.0001inch	Tool length compensation	S
Least input increment 1 / 10 inch/metric conversion	0.0001mm, 0.0001deg, 0.00001inch	Cutter compensation C	S
Store Stroke Check 1 / 2, Mirror Image	G20, G21	Tool life management	O
Operation		Tool length measurement	S
Automatic & MDI operation		Editing operation	
DNC operation by memory card	PCMCIA card is required	Part program storage length	1,280m (512kB) S
Dry Run, Single Block		Number of register able programs	400ea S
Manual handle feed / feed rate	1Unit / x1, x10, x100	Background editing	S
Feed function		Extended part program editing / Play Back	S
Rapid traverse override	F0, F25, F50, F100	Interpolation function	
Feedrate (mm/min)		Positioning / Linear interpolation / Circular interpolation / Dwell (Per seconds)	G00 / G01 / G02, G03 / G04 S
Feedrate override	0 ~ 150%	Cylindrical interpolation	4 - axis interface option is required S
Jog feed override	0 ~ 4,000mm/min	Helical interpolation	Circular interpolation plus Max.2axes linear interpolation S
Override cancel	M48, M49	Reference position return check / return	G27 / G28, G29 S
Program input		2nd, 3rd, 4th reference position return / Skip	G30 / G31 S
Tape code	EIA / ISO	Setting and display	
Optional block skip	9ea	Display unit	10.4" Color LCD S
Program number	O4 - Digits	Clock function	S
Sequence number	N8 - Digits	Self-diagnosis function / Alarm history display	S
Decimal point programming		Help function / Graphic function	S
Coordinate system setting	G92	Run hour and parts count display	S
Workpiece coordinate system	G54 - G59	Dynamic graphic display	O
Workpiece coordinate system preset		Multi-language display	English, German, French, Italian, Chinese, Spanish, Korean, Portuguese, Polish, Hungarian, Swedish, Russian S
Addition of workpiece coordinate pair	48ea	Data input / output	
Manual absolute on and off		Reader / Puncher interface CH1	RS232C S
Chamfering / corner R		Reader / Puncher interface CH2	RS232C S
Programmable data input	G10	Data server	256MB / 1,024MB O
Sub program call	10 folds nested	Ethernet Interface	S
Custom Macro B		Memory card interface	S
Addition of custom macro common variables	#100 - #199, #500 - #999	HWACHEON Artificial Intelligence	
Canned Cycles for Drilling		Hwacheon Artificial Intelligence Control System (HAI) 40 Block	S
Small-hole peck drilling cycle		Hwacheon Artificial Intelligence Control System (HAI) 200 / 400Block	O
Automatic corner override		Hwacheon Efficient Contour Control System (HECC)	S
Feedrate control with acceleration in circular interpolation		Hwacheon Tool Load Detect System (HTLD)	S
Scaling / Coordinate system rotation		Cutting Feed Optimization System (OPTIMA)	S
Programmable Mirror Image		Hwacheon Thermal Displacement Control System (HTDC)	S
Tape format for Fanuc series 10 / 11			
Manual Guide i			
Polar Coordinate System			
Spindle speed function			
Spindle override	50 - 120%		
Spindle orientation			



Hwacheon Global Network

☒ Hwacheon Headquarters ☒ Hwacheon Europe ☒ Hwacheon Asia ☒ Hwacheon America



HWACHEON

Please call us for product inquiries.

www.hwacheon.com

The product design and specifications may change without prior notice.
Read the operation manual carefully and thoroughly before operating the product,
and always follow the safety instructions and warnings labels attached on the surfaces of the machines.

HEAD OFFICE

HWACHEON MACHINE TOOL CO., LTD.

123-17, HANAMSANDAN 4BEON-RO, GWANGSAN-GU, GWANGJU, KOREA
TEL: +82-62-951-5111 FAX: +82-62-951-0086

SEOUL OFFICE

46, BANGBAE-RO, SEOCHO-GU, SEOUL, KOREA
TEL: +82-2-523-7766 FAX: +82-2-523-2867

USA

HWACHEON MACHINERY AMERICA, INC.

555 BOND STREET, LINCOLNSHIRE, ILLINOIS, 60069, USA
TEL: +1-847-573-0100 FAX: +1-847-573-9900

GERMANY

HWACHEON MACHINERY EUROPE GMBH

JOSEF-BAUMANN STR. 25, 44805, BOCHUM, GERMANY
TEL: +49-234-912-816-0 FAX: +49-234-912-816-60

SINGAPORE

HWACHEON ASIA PACIFIC PTE. LTD.

21 BUKIT BATOK CRESCENT, #08-79 WCEGA TOWER SINGAPORE 658065
TEL: +65-6515-4357 FAX: +65-6515-4358

HC-M282-R2.8-201605